

PRODUCT CATALOG

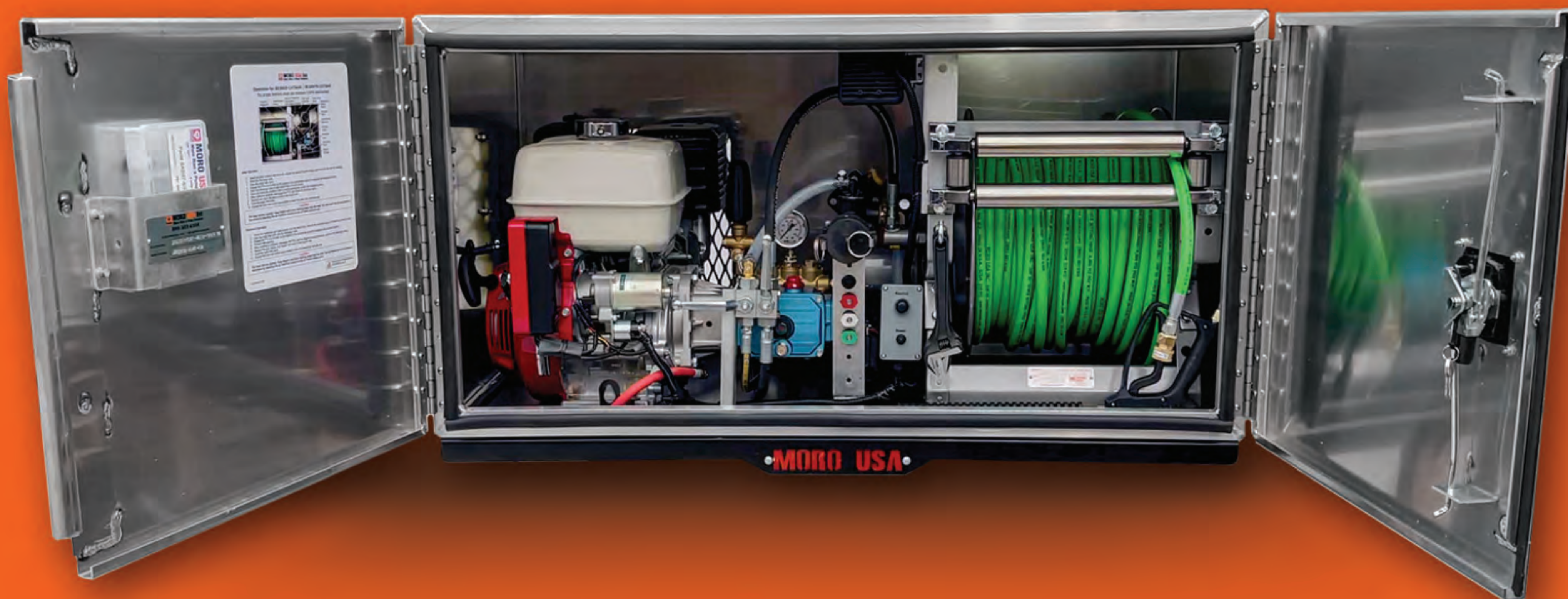

MOROUSA.COM

VISIT OUR WEBSITE FOR FULL CATALOG OF PRODUCTS



**WE ARE COMMITTED
TO OFFERING YOU
THE BEST IN THE INDUSTRY**



**NEW
REDESIGNED
WEBSITE!**

We have been busy developing and redesigning our website to make it easier and faster for you to find exactly what you need!



NEW FACILITY!

We are excited to announce our growth and expansion! With new products and innovative ideas, we have built a state-of-the-art facility to support our inventory management and product development needs.



NEW & REDESIGNED MORO PUMP PACKAGES!



MORO TURBO
630X3



MORO
BOLT&GO X3G

MORO PUMP PACKAGES



Moro pump packages are delivered to you ready to mount and available in multiple options to meet your specific needs. All packages are built durable and dependable for tough industrial duty applications

MORO TURBO X3

MORO TURBO 630X3

- Stainless Steel enclosure
- Moro PM90T Vacuum Pressure Pump
- Secondary shutoff
- Vacuum/Pressure Relief
- No spill pressure relief system
- Air operated 4 way valve (with external switch)
- External vacuum/pressure gauge
- External oil reservoir
- Exhaust Muffler
- Gearbox or Hydraulic driven
- Compact design **ONLY 42" wide**



MORO TURBO 850X3

- Stainless Steel enclosure
- Moro PM150T Vacuum Pressure Pump
- Secondary shutoff
- Vacuum/Pressure relief
- No spill pressure relief system
- Air operated 4 way valve (with external switch)
- External vacuum/pressure gauge
- External oil reservoir
- Exhaust Muffler
- Gearbox or Hydraulic driven
- Compact design **ONLY 42" wide**



MORO BOLT & GO X3

MORO BOLT & GO X3

Packages From 254-630 CFM

- Air | Fan | Liquid Cooled
- Secondary shutoff
- Vacuum pressure relief
- No spill pressure relief system
- Vacuum/Pressure gauge
- Exhaust muffler
- Gearbox or hydraulic driven
- Compact design **ONLY 42" wide**
- Available with air operated 4 way valve



Model: BOLT & GO 630X3

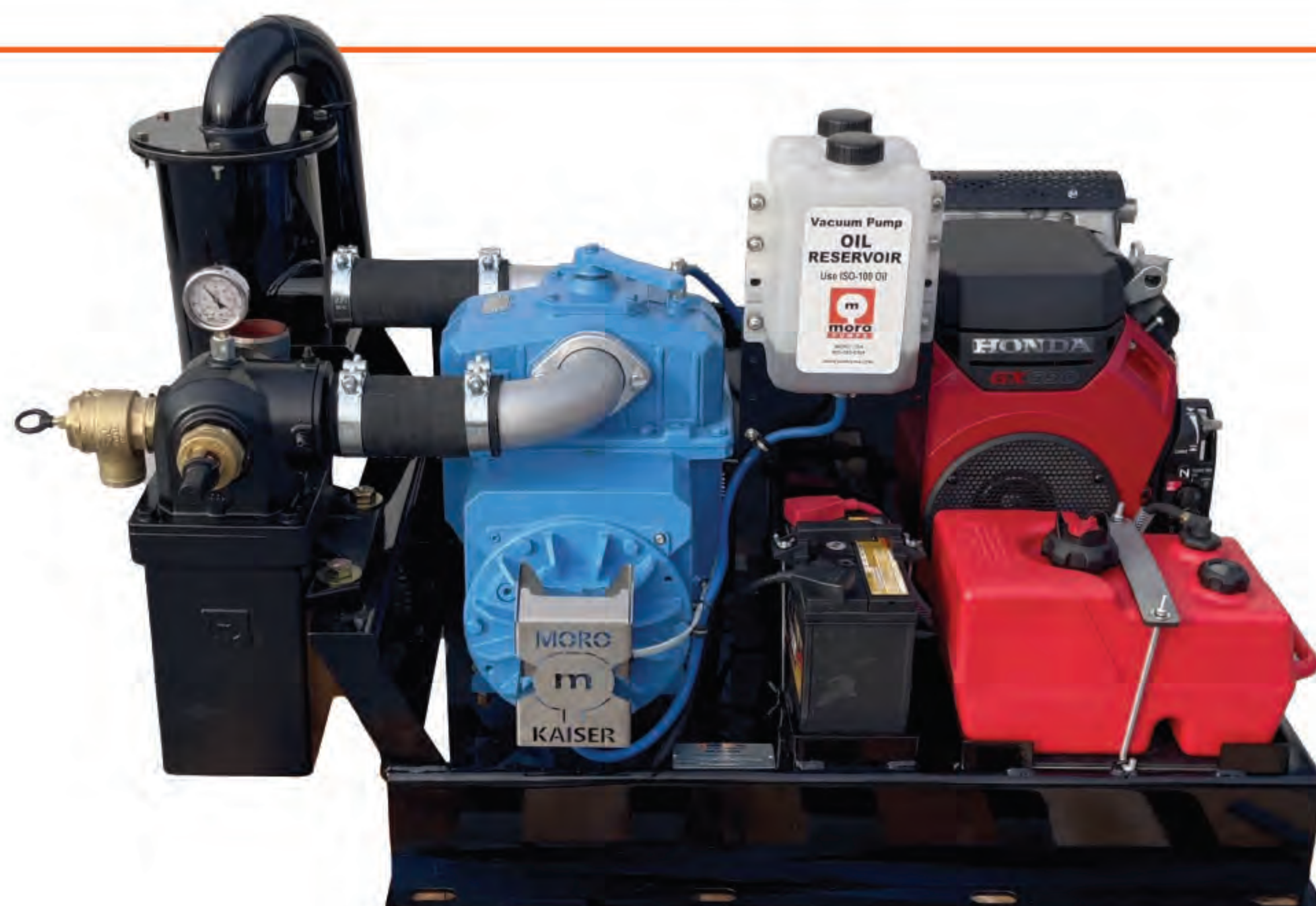

MORO BOLT & GO X3G

Packages From 254-630 CFM

- Air | Fan | Liquid Cooled
- Honda GX690 Engine
- Secondary shutoff with Pressure & Vacuum relief with gauge
- Mounted exhaust muffler
- Stand alone application
- Truck or trailer mount
- Ready to Bolt & Go
- Oil Reservoir
- Diesel Flush Kit
- Battery
- Fuel tank with gauge

MORO VACUUM PUMPS



FIELD PROVEN PERFORMANCE

Moro has over 70 years of experience building vacuum pumps.

Lower operating rpm = longer pump life
 Lower truck rpm = less fuel consumption
 Lower noise levels = quieter operation
 Lower oil consumption = lower operating costs

Each Pump is run at the factory and goes through a 20-point inspection before it's approved for final paint, packaging and shipment.

AIR COOLED VACUUM PUMPS



PM60A	
CFM	254
PSI	29
Weight	265 lbs
Hose	3"
Cooling	Air

PM70A	
CFM	332
PSI	29
Weight	309 lbs
Hose	3"
Cooling	Air

PM80A	
CFM	424
PSI	29
Weight	357 lbs
Hose	3"
Cooling	Air

DUAL FAN COOLED VACUUM PUMPS | TURBO SERIES



PM70T	
CFM	292
PSI	21.7
Weight	350 lbs
Hose	3"
Cooling	Dual Fan Cooling



PM100T	
CFM	460
PSI	29
Weight	550 lbs
Hose	4"
Cooling	Dual Fan Cooling



PM90T	
CFM	430
PSI	29
Weight	470 lbs
Hose	3"
Cooling	Dual Fan Cooling



PM150T	
CFM	546
PSI	29
Weight	529 lbs
Hose	4"
Cooling	Dual Fan Cooling

LIQUID COOLED VACUUM PUMPS | W-SERIES



PM60W	
CFM	254
PSI	29
Weight	387 lbs
Hose	3"
Cooling	Liquid

PM80W	
CFM	424
PSI	29
Weight	480 lbs
Hose	3"
Cooling	Liquid

PM110W	
CFM	630
PSI	29
Weight	645 lbs
Hose	3" or 4"
Cooling	Liquid

LIQUID COOLED VACUUM PUMPS | STORM SERIES



M9	
CFM	547
PSI	14.5
Weight	970 lbs
Hose	4" Flange
Cooling	Liquid

PM200	
CFM	678
PSI	14.5
Weight	970 lbs
Hose	4" Flange
Cooling	Liquid



HM46	
CFM	1642
PSI	14.5
Weight	1587 lbs
Hose	6" Flange
Cooling	Liquid

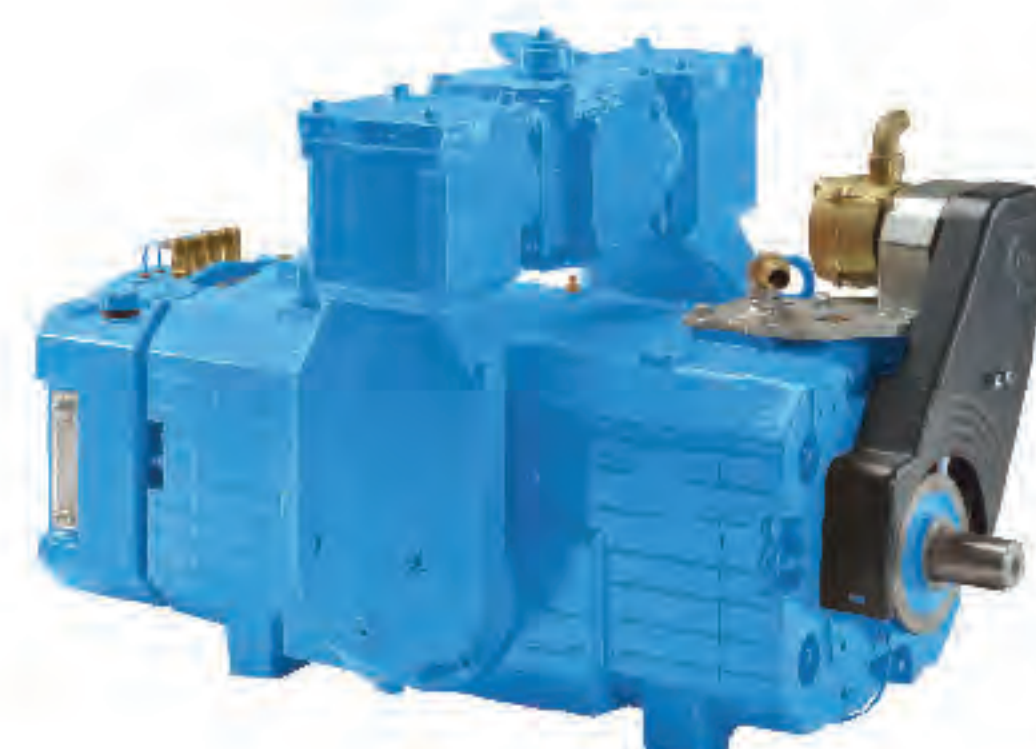

PM2000	
CFM	833
PSI	29
Weight	1031 lbs
Hose	4" Flange
Cooling	Liquid

PM3000	
CFM	1001
PSI	29
Weight	1177 lbs
Hose	4" Flange
Cooling	Liquid



NEW

MORO HIGH PRESSURE DC-10 WASHDOWN FILL PUMP KITS

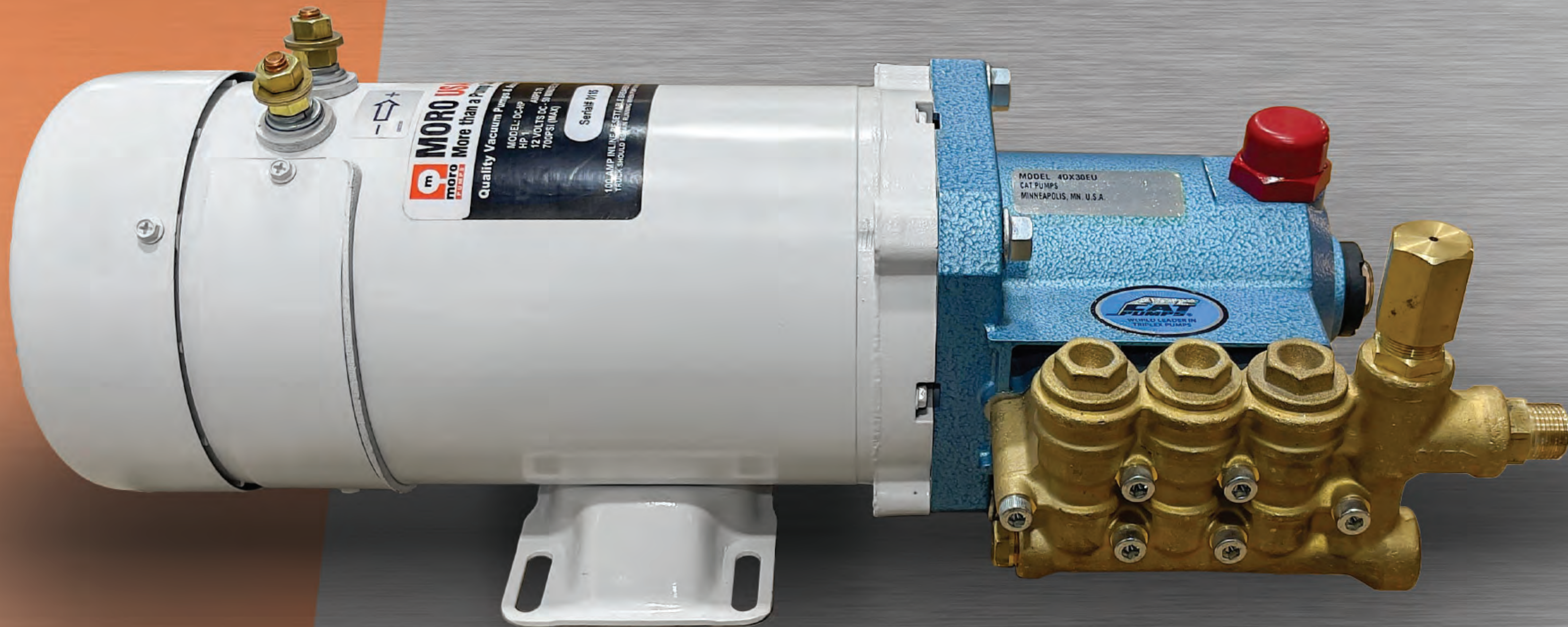
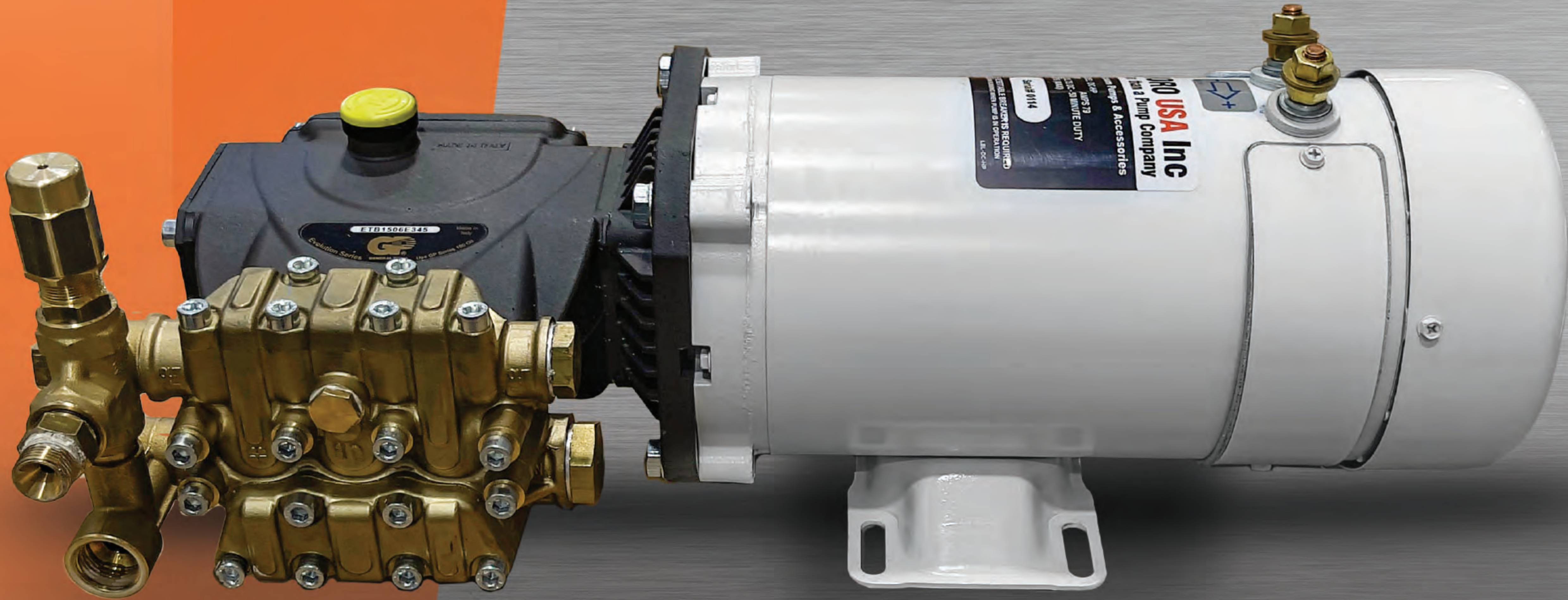

**KITS INCLUDE PRESSURE SWITCHES, INLET FILTER,
50' HOSE, LANCE, & WASH NOZZLE**



MORO WASHDOWN/FILL PUMPS



FEATURES

- 1-HP 12-Volt DC epoxy coated motor for superior rust protection
- 1" Discharge
- 1-1/4" Intake
- Unbreakable stainless steel impeller
- Pressure Switch Available
- 12V Solenoid Available



DC-10 STAINLESS STEEL

DCSS

GPM 20

PSI 42

Volts 12

Amps 79

Impeller Stainless

Body Stainless



DC-10 CAST IRON

DCCI

GPM 20

PSI 42

Volts 12

Amps 79

Impeller Stainless

Body Cast Iron



DC-10 HIGH VOLUME

DCCI-HV

GPM 50

PSI 20

Volts 12

Amps 79

Impeller Stainless

Body Cast Iron



DC-10 HIGH PRESSURE - CAT

DC-HP-CAT

GPM 1.5

PSI 700

Volts 12

Amps 79

Kit includes pressure switches, inlet filter, 50' hose, lance, & wash nozzle



DC-10 HIGH PRESSURE - GP

DC-HP-GP

GPM 1.5

PSI 700

Volts 12

Amps 79

Kit includes pressure switches, inlet filter, 50' hose, lance, & wash nozzle



HIGH PRESSURE PUMPS

CAT



GENERAL



FLOW: 0.5 GPM to over 230 GPM
Pressure Range: 1200 to over 21,000



ALL NEW REDESIGNED JETTER BOXES!

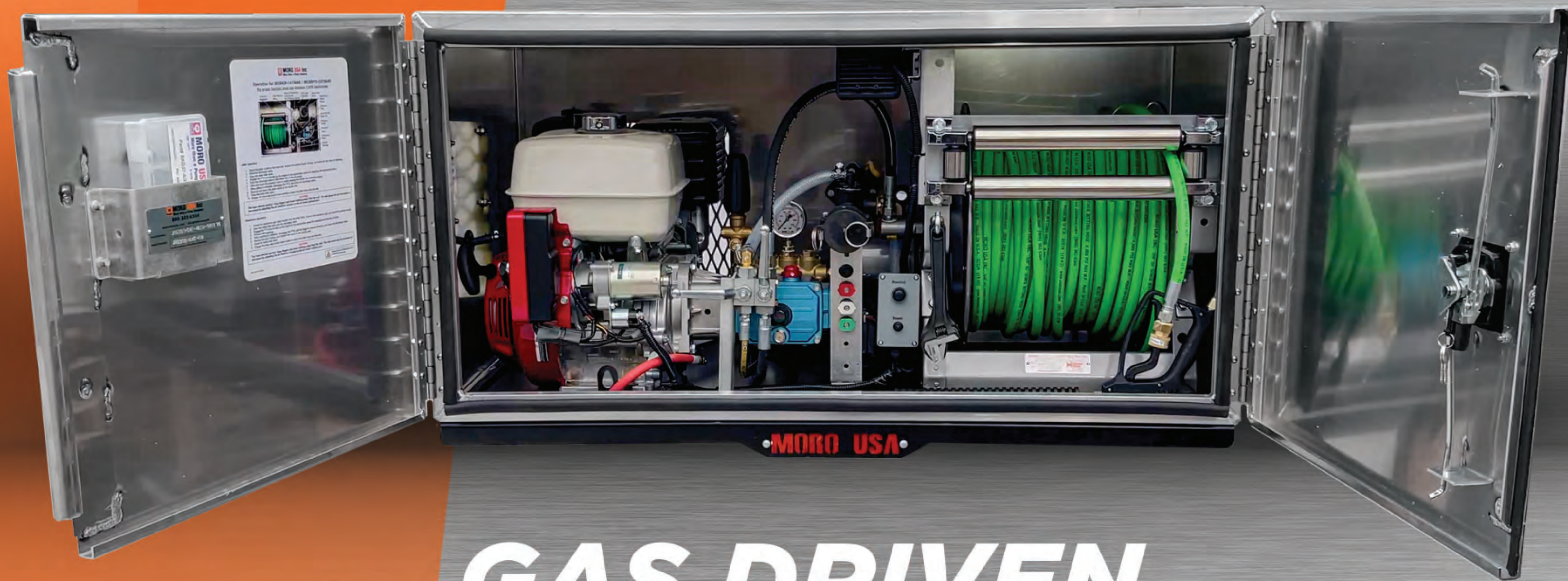

GAS DRIVEN

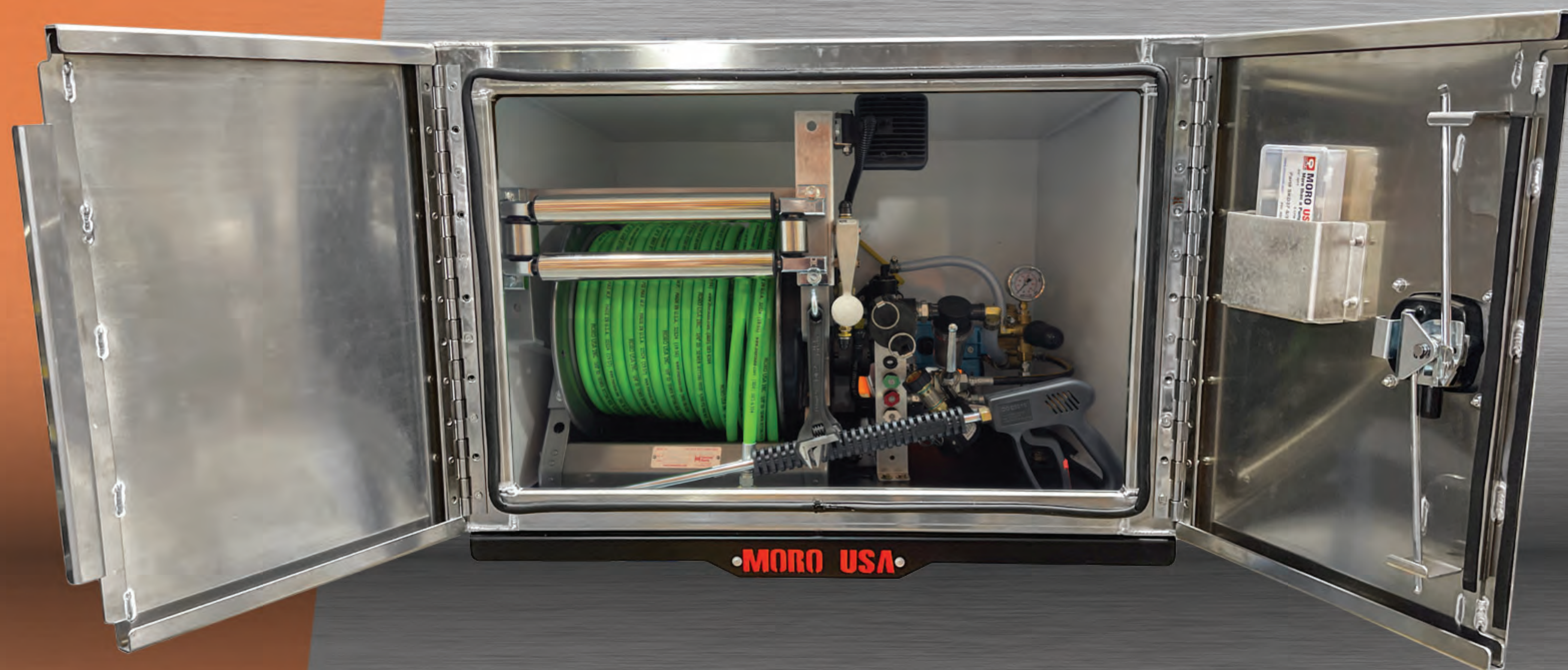

GEARBOX DRIVEN

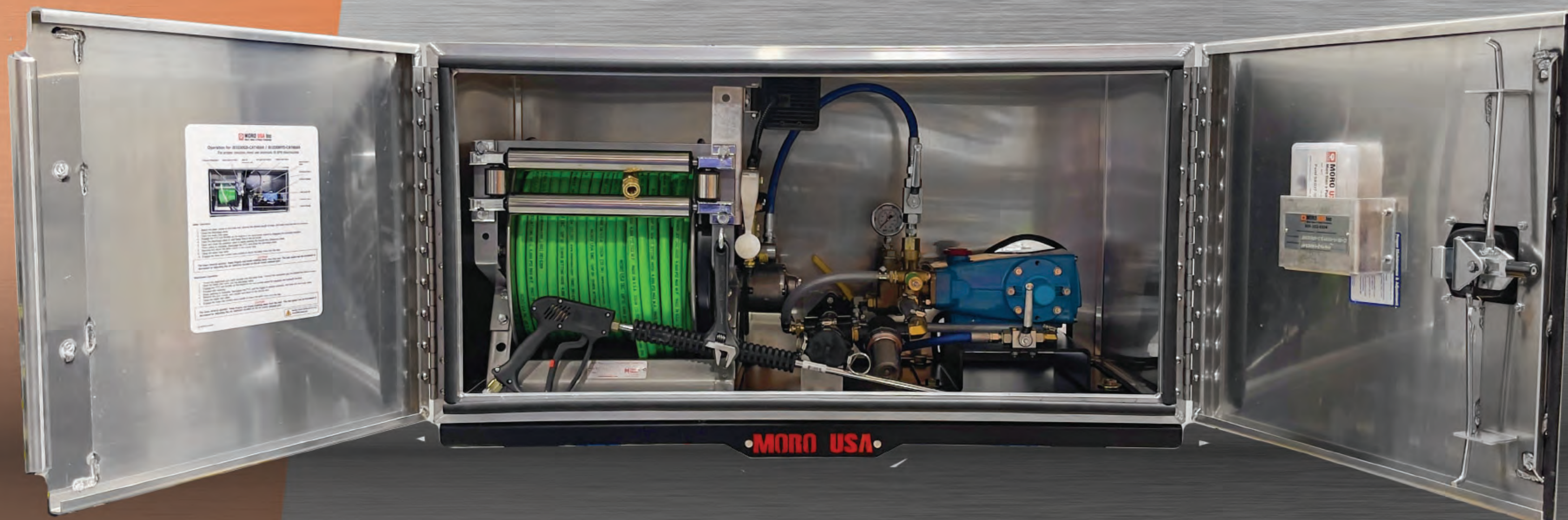

HYDRAULIC DRIVEN

MORO JETTER BOX PACKAGES



ALL JETTER PACKAGES INCLUDE THE FOLLOWING

- Aluminum boxes
- Factory attached under box support
- Adjustable mounting kit that allows mounting using the existing frame holes
- High pressure CAT or GP jetter pump with unloader & conveniently located pulsator valve
- Available in Electric or Air Hannay Reels
- 200' 3/8" x 4000 PSI Jetter Hose
- Gearbox models have a mount that moves in and out for drive shaft alignment
- Fast reservoir fill / hose connection with built in filter strainer and shut off valve
- Standard jetter nozzles with storage
- Wash down gun with quick disconnect 0°, 15°, 25°, and 40° nozzles
- 2 adjustable wrenches
- LED work light with switch
- All factory pre-set and ready to use (no adjustments needed)
- Shut off valve to reel (for jetter nozzle changing)
- Optional heater available

GAS DRIVEN

**5 GPM 3000 PSI
48" X 24" X 24" BOX
HONDA ELECTRIC START ENGINE
WITH REMOTE FUEL TANK**



**10 GPM 3000 PSI
60" X 24" X 24" BOX
HONDA ELECTRIC START ENGINE
WITH REMOTE FUEL TANK**



GEARBOX DRIVEN

**5 GPM 3000 PSI
36" X 24" X 24" BOX**



**10 GPM 3000 PSI
48" X 24" X 24" BOX**



HYDRAULIC DRIVEN

**5 or 10 GPM 3000 PSI
36" or 48" X 24" X 24" BOX**



**16 GPM 3000 PSI
HYDRAULIC DRIVEN WITH HYDRAULIC MOTOR**

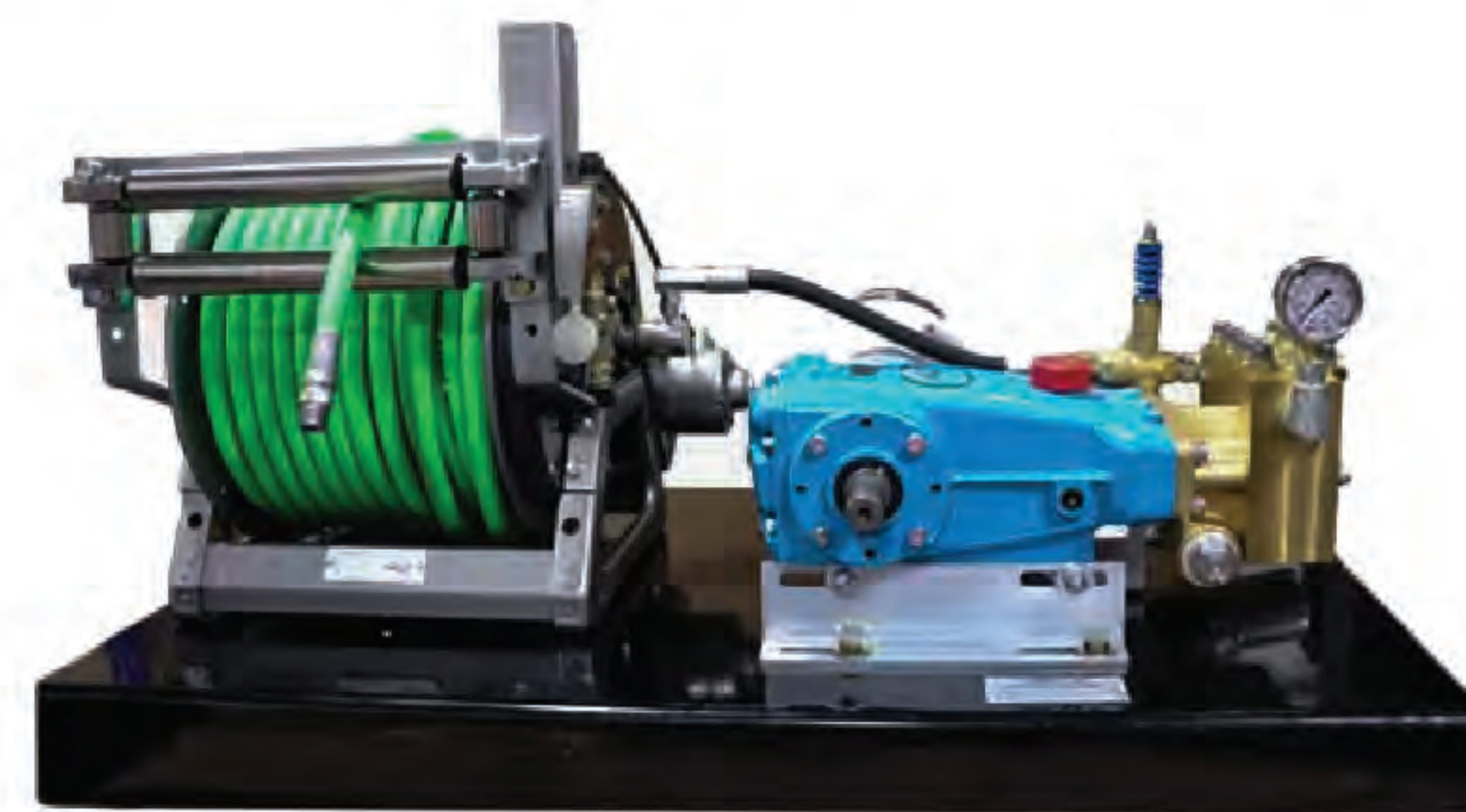

CUSTOM MODELS AVAILABLE CALL 417.787.8400

AVAILABLE IN CAT PUMPS OR GENERAL PUMPS





NEW VALVE COMBOS & KITS



**2"-6" RIV BRASS LEVER GATE VALVE COMBOS
AVAILABLE IN NPTXNPT, & FLGXNPT**

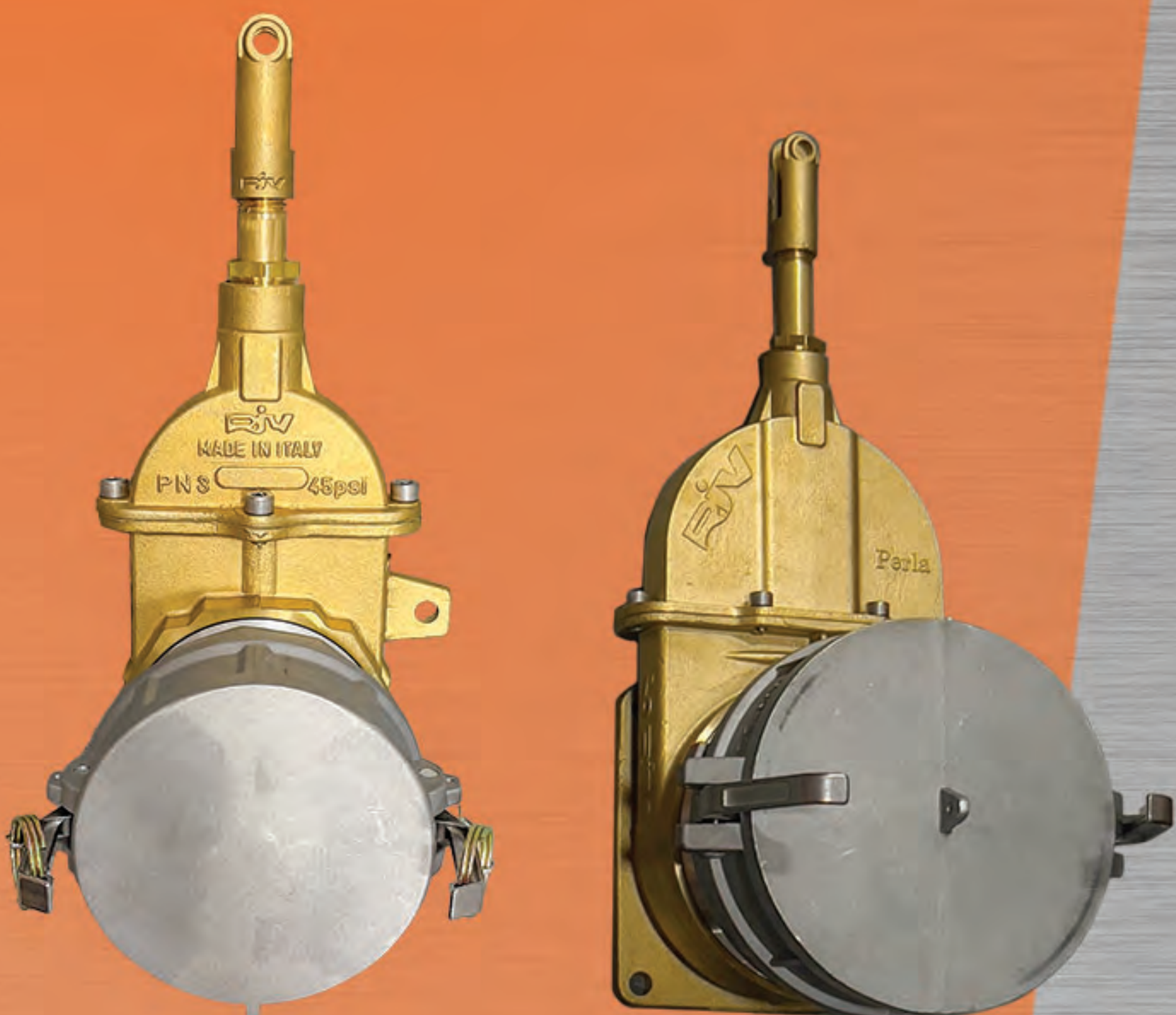

**4" & 6" RIV BRASS
PISTON VALVE COMBO**

**AVAILABLE IN
NPTXNPT & FLGXNPT**

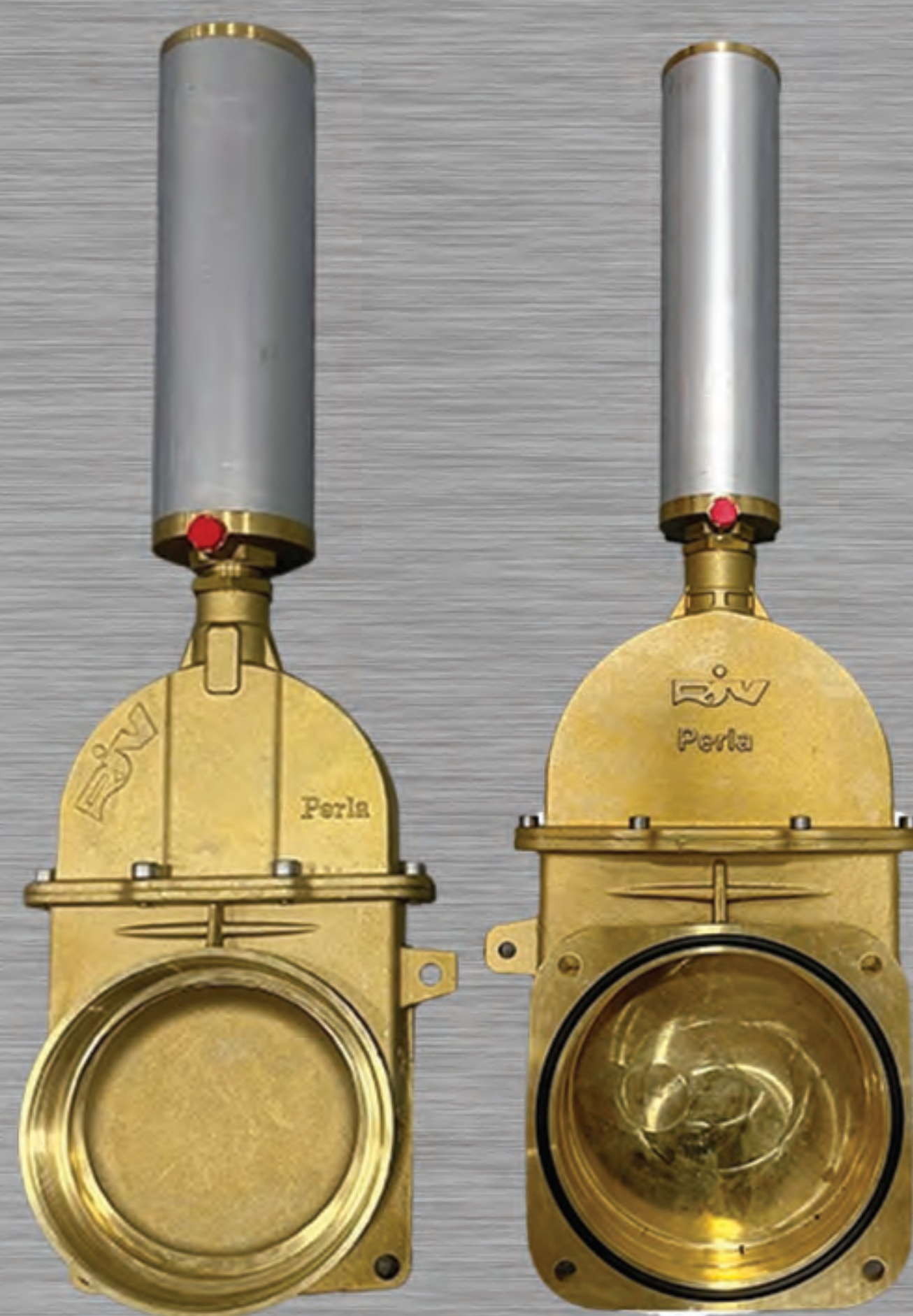

**4" & 6" RIV BRASS
PISTON VALVE KITS WITH
AIR OR HYDRAULIC ACTUATOR**

**AVAILABLE IN NPTXNPT,
FLGXFLG, & FLGXNPT**



**4" & 6" RIV BRASS
PISTON VALVE COMBOS WITH
AIR OR HYDRAULIC ACTUATOR**

**AVAILABLE IN
NPTXNPT & FLGXNPT**



**3"-6" BUTTERFLY VALVE
MANUAL OPERATION OR WITH
SINGLE OR DOUBLE ACTING
AIR ACTUATOR KIT**



**4" MORO 4-WAY VALVE
WITH AIR ACTUATOR
ALSO AVAILABLE IN
MANUAL OPERATION
IN BOTH 4" & 6"**

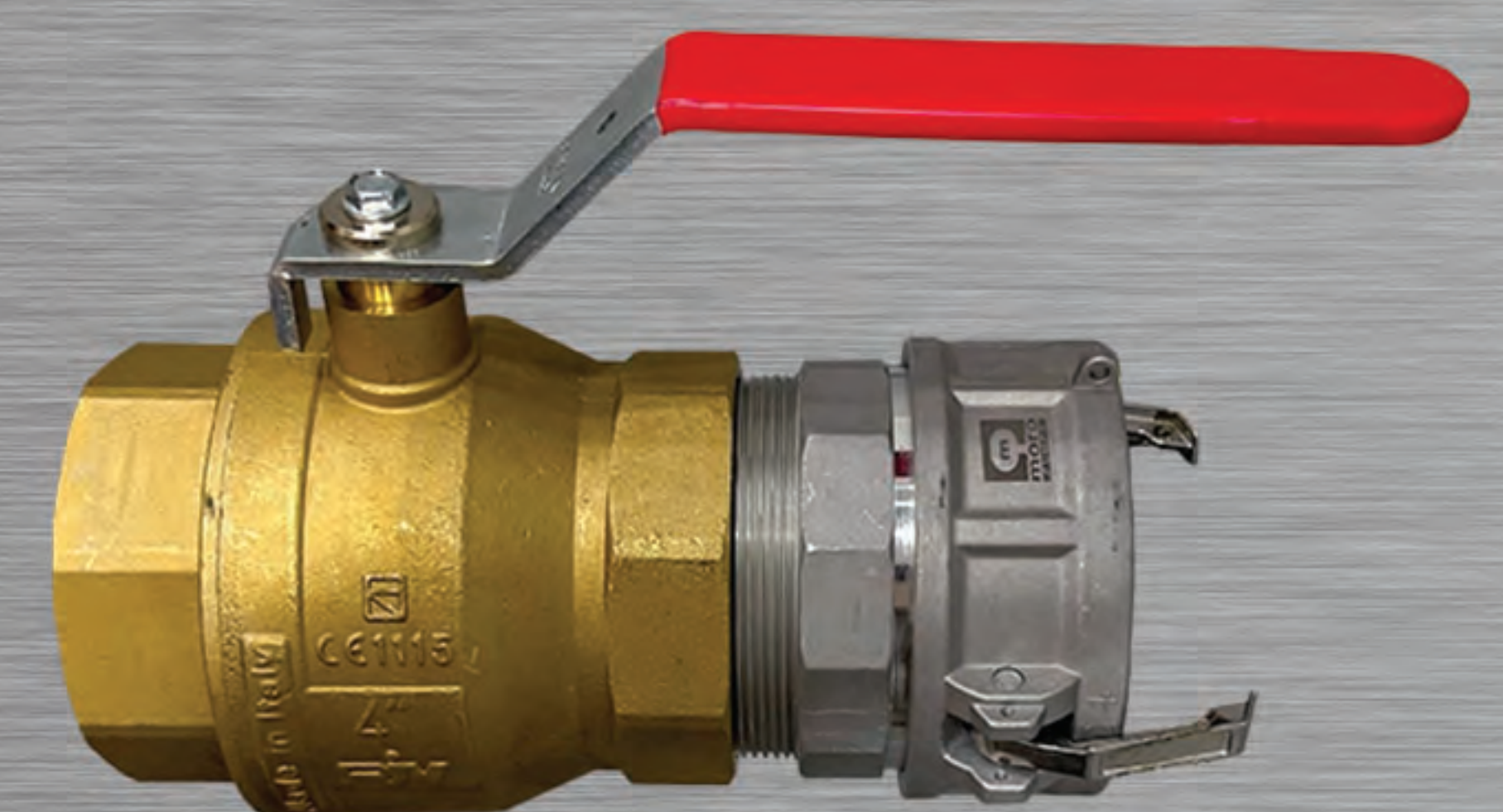

**2"-4" RIV BRASS
BALL VALVE COMBOS**

VALVES

Lever Valves



2" - 6"
NPT X NPT
FLG X NPT

Piston Valves & Air Cylinders



4" - 8"
NPT X NPT
FLG X NPT
FLG X FLG

Ball Valves



1/2" - 4"

Valve Heaters



3" 4" & 6"
12 Volt Heater
for Lever Gate Valves
4" 6" & 8"
Liquid Tube Heater
for Piston Valves

Butterfly Valves



3" - 6"
Available With
Air Actuator

Valve Combos



2" - 6"
Lever or Piston

Pressure & Vac Valves



Vacuum



Pressure

Safety Valves



Vacuum
2", 2.5", 3"



Pressure
2", 2.5", 3"

CAM & GROOVE FITTINGS

C



DC



E



F



2" - 6" sizes/other styles available

TANK COMPONENTS & ACCESSORIES

Oil Catch Mufflers



MMA 270T - 3" / 271T - 4"
Side entry / pre-fabricated discharge

Relief Valve Tree



Diesel Flush Deluxe Kit
Also Available

Sight Eyes



2" - 3"

5"

Press/Vac Gauges



MORO
Vacuum/Pressure
Gauge

Gasket Seals



MORO 21' Fluted Style &
22' NBR-60
Rear Door Gasket Seals

SUCTION BOOMS

Hydraulic telescoping control suction boom offers 320 Degree Rotation

FEATURES

- 4", 6", 8" Hose
- Parking Brake
- Hydraulic Rotation
- Pendant Control Supports
- 12 Volt Solenoid Valves

MODELS

- 4" 320 Degree
- 6" 320 Degree
- 8" 320 Degree

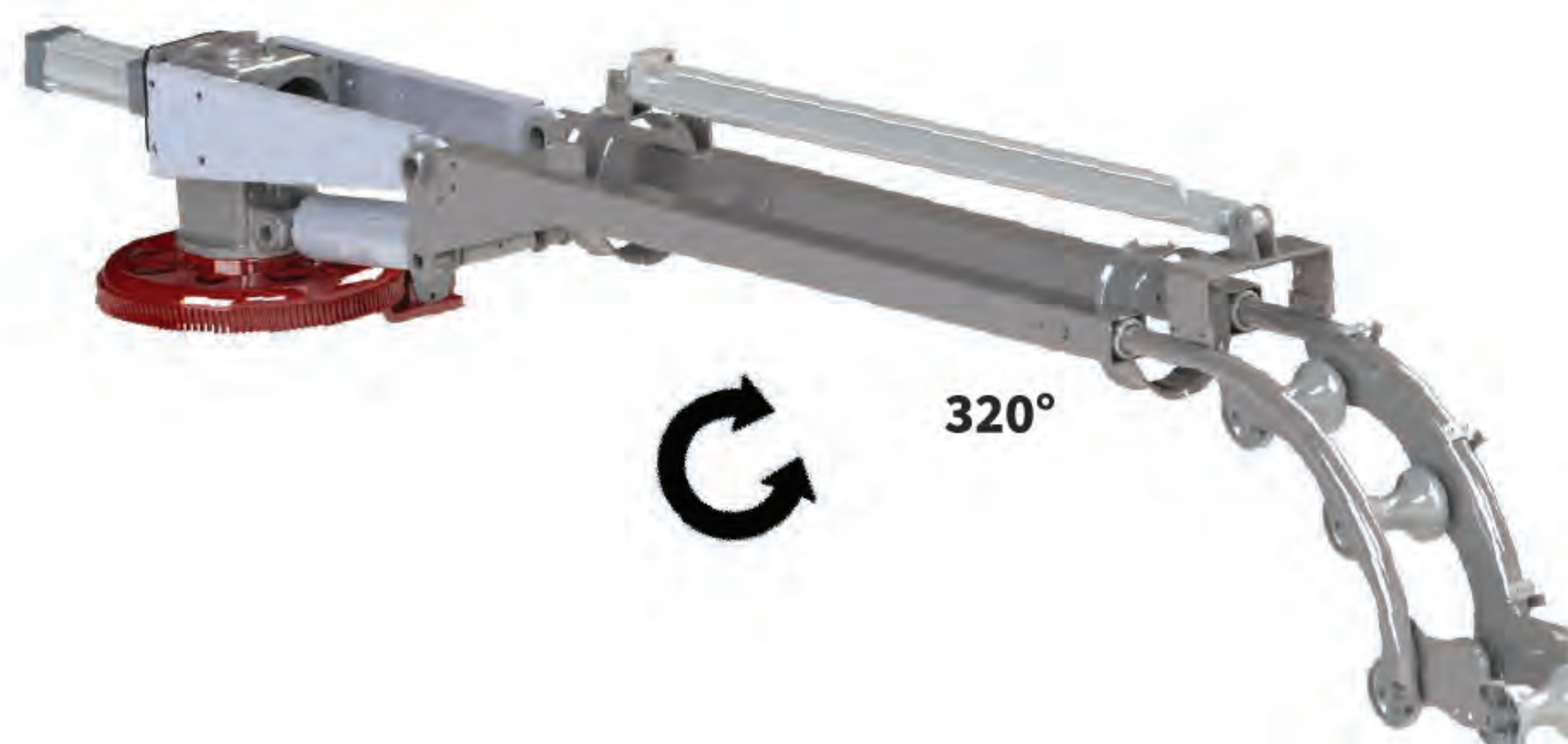

PUMP REPAIR SERVICES



MORO USA will rebuild any pump regardless of original manufacture!

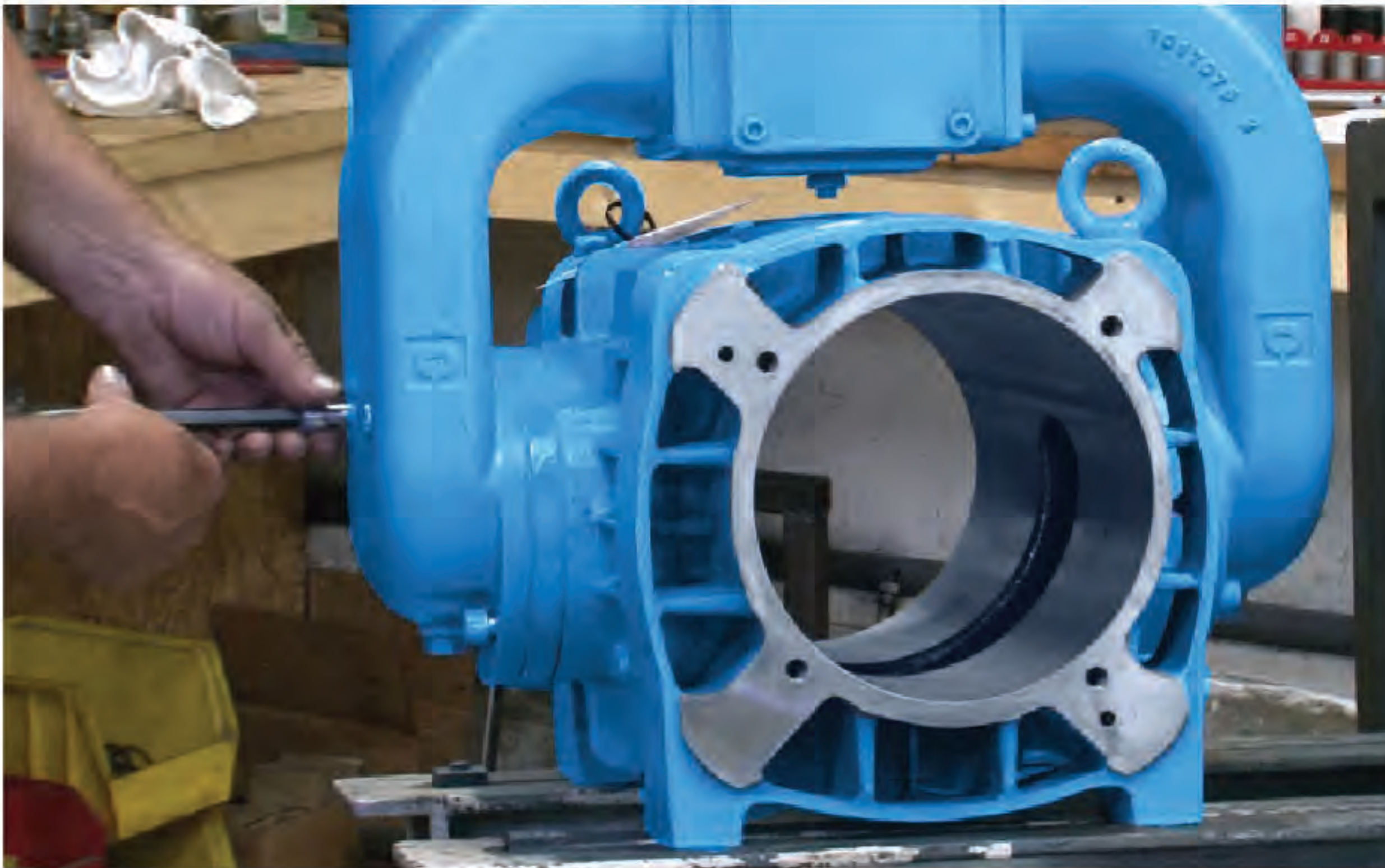

PROBLEMS WITH YOUR PUMP?

Give us a call today and see how we can help you with your pump repair

412.787.8400

REBUILT PUMPS

VANE PUMPS
BLOWER PUMPS
LIQUID RING PUMPS
PLUNGER PUMPS

FACTORY VACUUM PUMP REBUILD KITS

LOOKING TO REBUILD YOURSELF?

MORO Sells Rebuild Kits for all MORO Pumps!
High quality Moro factory vacuum pump replacements parts will ensure hour after hour of trouble-free operation.

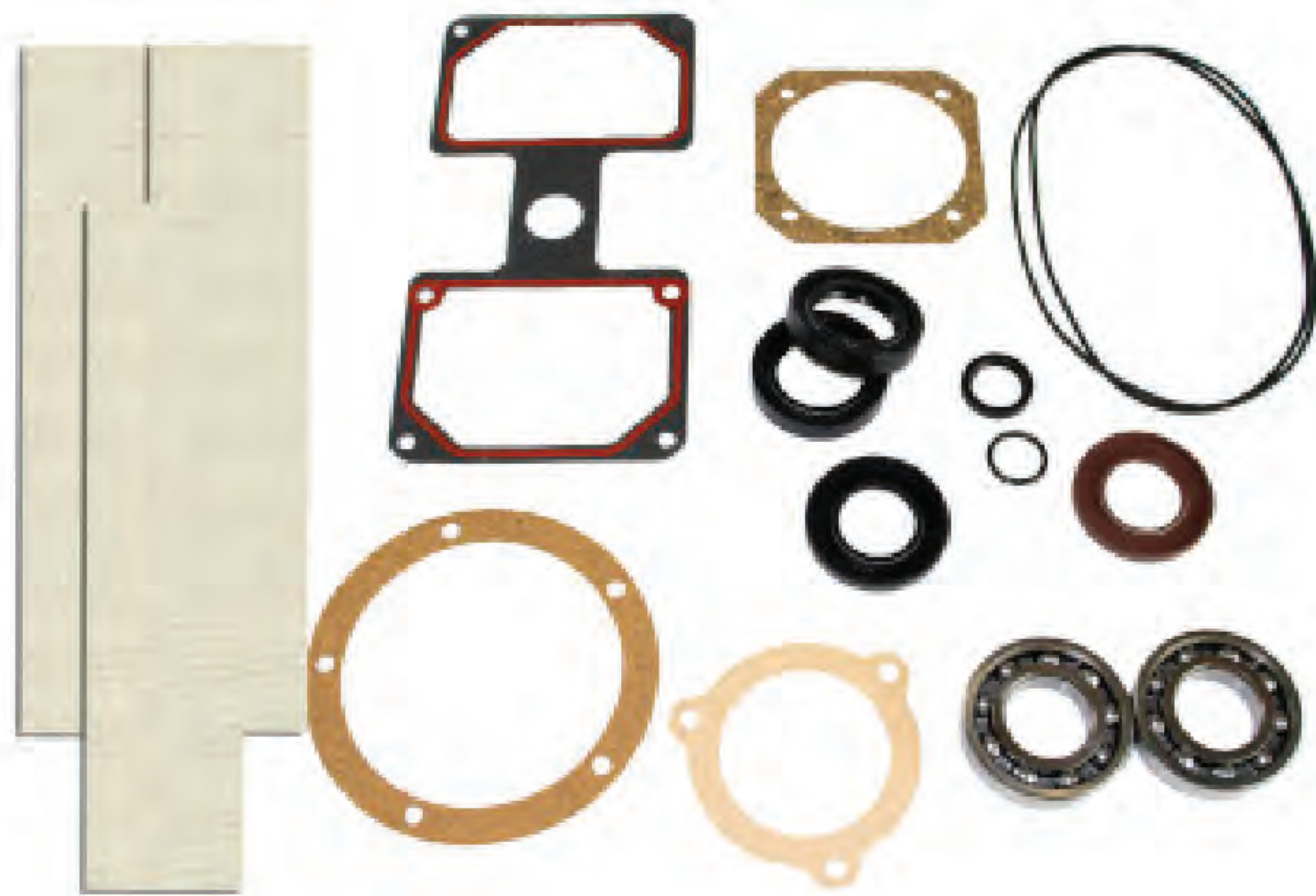

KITS INCLUDE

GASKET KIT
KEVLAR VANES
O-RINGS
SEALS
Kits maybe ordered with or without bearings

PLACE YOUR ORDER TODAY!

MOROUSA.COM

DETAILED PRODUCT INFO | CUSTOM ORDERING | OEM PRICING

Corporate Office/Warehouse
7059 Hwy 47
Union, MO 63084 | 636.584.8844
Hours: 8:00am - 4:00pm EST

Sales/Warehouse
204 Parkway View Drive
Pittsburgh, PA 15205 | 412.787.8400
Hours: 7:00am - 4:00pm EST